

# LUXAFLEX® *Folding Arm* AWNINGS



SIMPLY **SMARTER** BY DESIGN





# LUXAFLEX® *Folding Arm* Awnings

---

## **OVERVIEW:**

The LUXAFLEX® Contemporary series of Folding Arm Awnings was developed to bring the latest in design, styling and quality to the Australian market. The awning series was developed to meet the market demand for modern and contemporary hardware systems that suit the newest architectural design trends.

## **THE FEATURES OF THE LUXAFLEX FOLDING ARM AWNING RANGE INCLUDE:**

The Luxaflex Folding Arm Awnings range features 4 awning styles that can meet the needs of any application.

Each model has been intelligently designed to incorporate a variety of options as standard. For example drainage front rails on every model, adjustable pitch at installation and a self-levelling front rail.





## Folding Arm *Awnings* Styling

Each model has its own unique design characteristics that give home owners a variety of aesthetical options to suit the design of their home. These include:

Ventura model has a range of accessories that allow you to customise the design of your awnings. This now includes the all new Ventura Terrace option that has been intelligently designed to offer an awning with a narrow width and long projection.

Garda model features an oval design semi cassette. The oval shape provides for a softer and lighter look which makes the Garda Awning ideal for homes with design curves.

The Nisse Folding Arm Awning is a traditional rectangular design which is understated and will suit almost any style of home. The Nisse is a compact sized full cassette awning with sleek lines that add a contemporary finish to any home.

Similar to the Nisse Awning, the Como Folding Arm Awning is a traditional rectangular design that features a large full cassette construction. This feature of the Como makes it ideal for applications requiring a large awning with a contemporary design.



# Benefits of *Awnings* to your home

## DID YOU KNOW?

Windows are a big source of unwanted heat loss and heat gain in your home. Choosing the right window coverings means you can improve the comfort of your home all-year-round, reduce your power bills and cut carbon pollution.

## IMPACT OF THE SUN ON YOUR HOME

Throughout the day, the sun moves from sunrise in the East through the North sky and sets in the West. This means the amount of heat from the sun received by a window varies according to the orientation and time of year. In summer, the sun travels higher through the sky with direct exposure to the East and West windows, in winter the sun travels lower with a greater angle through North facing windows. Each home is different, window size, orientation, glazing treatment, shading and internal coverings can have a significant impact of energy efficiency and comfort.

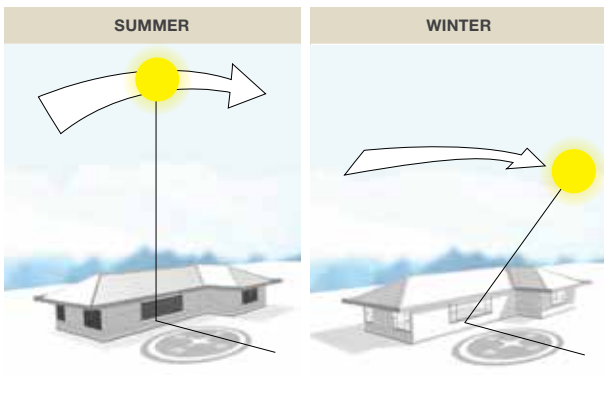

Luxaflex Folding Arm Awnings easily retract and extend providing the perfect solution for your home, year round.

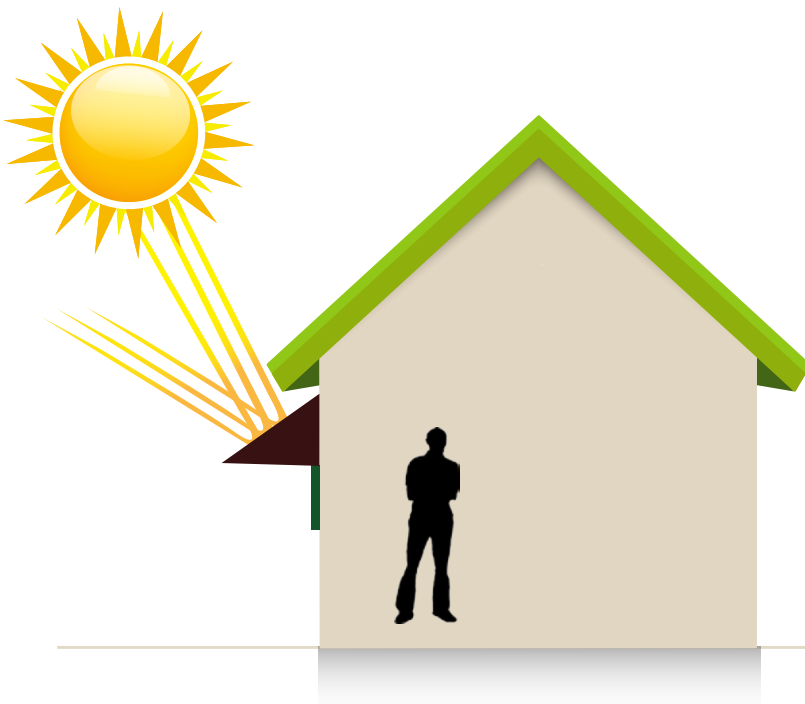

SIMPLY SMARTER BY DESIGN

## KEEP YOUR HOME COOL IN SUMMER



During summer, about half of unwanted heat comes through exposed windows, especially those facing east and west.

Shading your windows with LUXAFLEX® Awnings can minimise heat in your home to create a comfortable cooler environment – and save you hundreds on energy bills.

## Heat Reflection

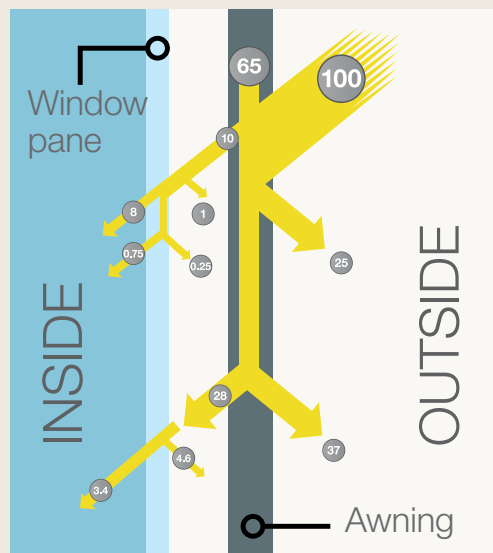

## KEEP YOUR HOME WARM IN WINTER



You can control the temperature of your home in winter without relying on power-hungry heating appliances.

To make the most of sunny days, open your awnings on windows facing the sun – this will let in sunlight and warmth, and will help to minimise the need to use your heating system. Keep the warmth inside during winter using well-fitted insulating window coverings such as LUXAFLEX® DUETTE® Architella Shades.

## Folding *Arm Awnings* Open Roller



### **TREND HOOD**

The Trend Hood is fully integrated into the construction of the Ventura Folding Arm Awning. Not only does it significantly change the aesthetics of the awning it also provides fabric protection when the awning is retracted. The hood angle is fully adjustable to suit users' preference at the time of installation.

Available with Ventura FAA



### **STANDARD RAIN HOOD**

This sleek and modern solid aluminium rain hood provides excellent protection for fabric when the awning is retracted. Additionally, it mounts flush against a flat wall surface ensuring no water run off behind the awning's mounting point. Available in standard and powder coat colour finishes.

Available with Ventura FAA, Ventura Terrace FAA Awning.

(Only available on Face Fit installations)



# Folding *Arm Awnings* Open Roller



## Ventura Terrace

New to the range is the Ventura Terrace Awning. An ideal solution for apartments, patios and terraces that require a narrow awning with a long projection. The clever design of the Ventura Terrace Awning allows for the arms to be offset one above the other creating an awning with a narrow width and a projection of up to 4 metres. The functionality of the Ventura Terrace Awning allows it to span widths from 2 - 14 metres at a projection of 4 metres and provides maximum flexibility for all types of applications.



### VARIABLE VALANCE

The Variable Valance option allows the user to control the height for the retractable valance for additional privacy and shade.



### WIND PROTECT SYSTEM (WPS)

With the custom Wind Protect System, the Ventura Folding Arm Awning can withstand higher wind forces\*. By stabilising the front bar, less strain is put on the hardware therefore extending the awning's life. With removable feet and front rail clip, the telescopic wind protect poles collapse for easy storage when not in use. Available for heights between 2 - 2.5 metres from ground to front rail.

Available with Ventura FAA and Ventura Terrace FAA.

\*Please refer to the price list for details.



## Folding *Arm Awnings* Semi Cassette

Designed in a beautiful and distinctive ergonomic oval shape, the Garda Folding Arm Awning is made from special hardened aluminium making this a strong, sturdy and sleek design perfectly suited to modern architectural design curves.



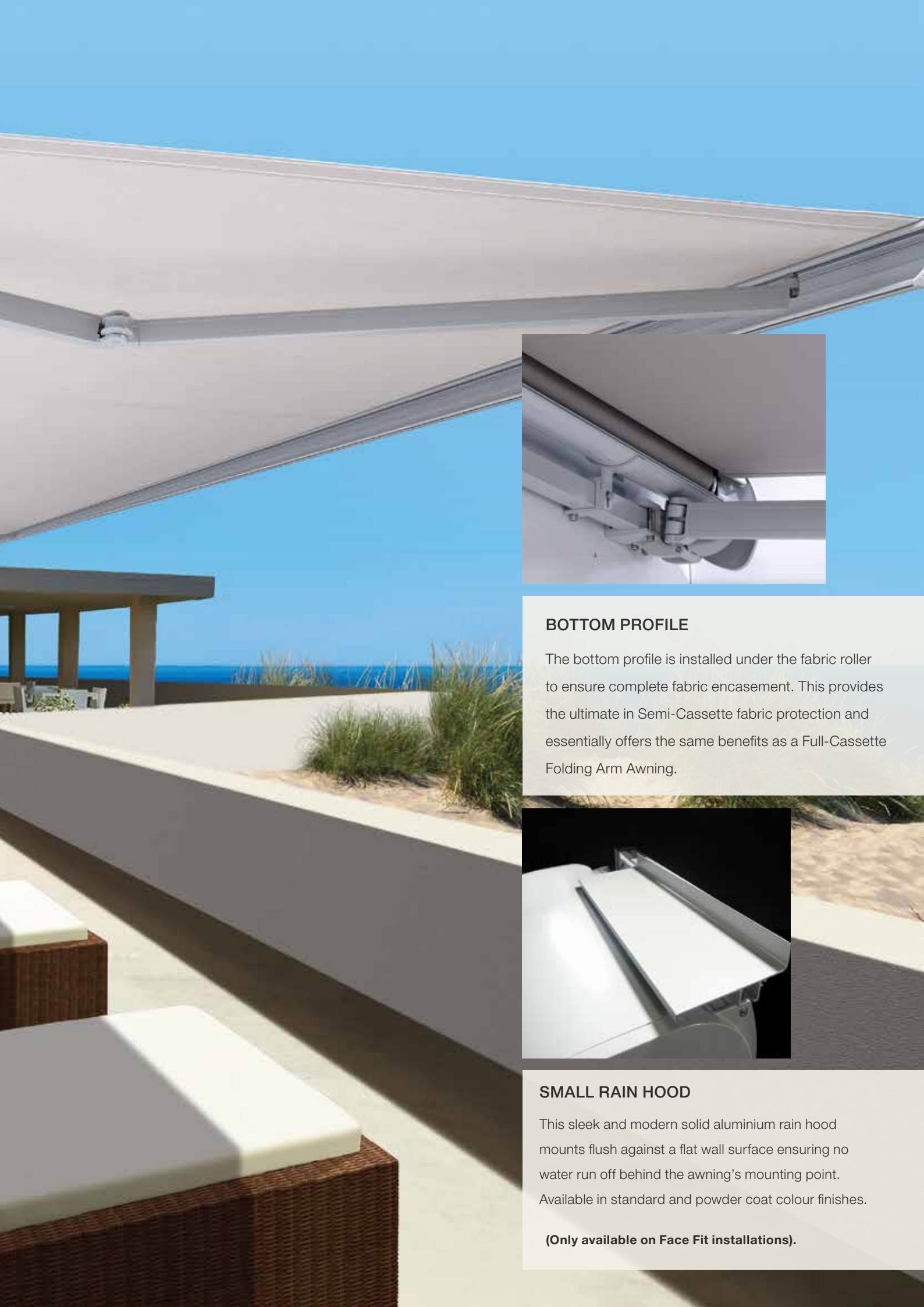

### **BOTTOM PROFILE**

The bottom profile is installed under the fabric roller to ensure complete fabric encasement. This provides the ultimate in Semi-Cassette fabric protection and essentially offers the same benefits as a Full-Cassette Folding Arm Awning.



### **SMALL RAIN HOOD**

This sleek and modern solid aluminium rain hood mounts flush against a flat wall surface ensuring no water run off behind the awning's mounting point. Available in standard and powder coat colour finishes.

**(Only available on Face Fit installations).**

# Folding *Arm Awnings* Full Cassette

---

Designed in a simple, non obtrusive rectangular design, this awning will complement the look of any style of architecture.

The fully concealed stylish and modern cassette provides protection to the awning's mechanism, arms and fabric for years of trouble free operation. The standard installation brackets are concealed behind the awning and are not visible when looking up at the awning.

The Como and Nisse Folding Arm Awnings represent the top level of Folding Arm Awning luxury. The Luxaflex Full Cassette Awning range features two models:



Similar to the Nisse, the Como features a full sized cassette awning capable of covering an area of 6.5 metres wide and 4 metres projection. The Como also features the option of coupling two awnings to cover an area up to 13 metres wide and 4 metres projection, making the Como a fully featured and versatile awning.

The compact size of the Nisse helps position it between the Garda and Como awnings and provides an opportunity for consumers to step up to a full cassette awning.





## Nisse Awning

The Nisse is a compact sized full cassette awning. Designed to be unobtrusive, the Nisse Awning is capable of covering an area of 5 metres wide and 3.5 metres projection, making the Nisse Awning a versatile and modern addition to any home. The increasingly popular small sized compact full cassette awning offers strength and durability against the harsh Australian environment while keeping the consumer's home cool and protecting against harsh UV radiation.

# LUXAFLEX® *Folding Arm Awnings* Options and Accessories

## HOME AUTOMATION:

The Luxaflex range of awnings offer a range of control options aimed at maximising flexibility and ease of use for consumers. These options include:



The Crank control provides a cost effective method of operating your awning.



Motor Control

A range of external motor solutions allows the Luxaflex Folding Arm Awnings to be operated at the touch of a button or via a wall switch.

These motor controls feature a range of options including a sun sensor that is designed to extend your awning and provide shade to your home, as well as wind sensors designed to retract your awning during windy conditions and prevent damage to your awning.

Wind sensor options includes:



Anemometer style with a fan that spins in the wind. As the wind speed picks up, the sensor signals the awning motor to retract the awning.



Eolis 3D sensor is mounted on the front of the folding arm awning and uses a motion detector to sense the effects of the wind on the awning. As the wind speed picks up, the sensor signals the awning motor to retract the awning.

## POWDER COATING:

Luxaflex Folding Arm Awnings feature hardware powder coated in colour Silver as standard. This offers the latest in contemporary external colour design trends. In order to maximise flexibility, you also have the choice of any of the Dulux powder coat colours to choose from.

Allowing consumers to truly customise their awning to match their home's exterior.

Based on recent trends below are the top ten trending colours for awning hardware:



Silver Pearl

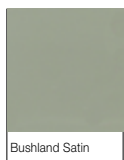

Bushland Satin



Black Matt



White Satin



White Birch



Woodland Grey

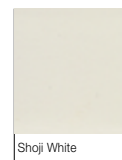

Shoji White



Paperback Satin



Ironstone Satin

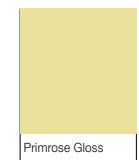

Primrose Gloss











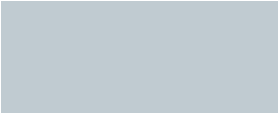

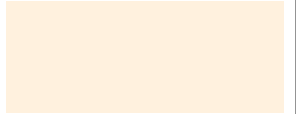

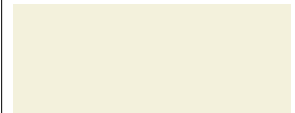
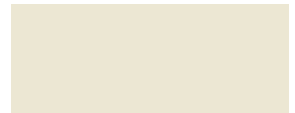







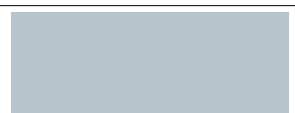

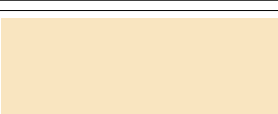
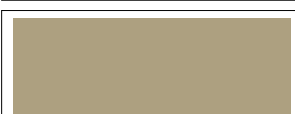
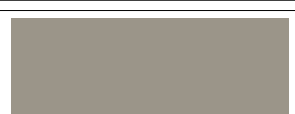
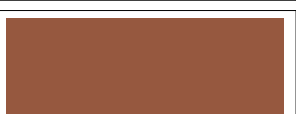

## HEAVY DUTY HARDWARE:

Luxaflex Folding Arm Awnings are made to the highest quality standards. In line with this, all the major components are made from special hardened cast aluminium ensuring strength and longevity. This also minimises the potential for chipping and scratching allowing the awning to look as good as new for years to come.

All Luxaflex Folding Arm Awnings also utilise a heavy duty steel galvanised roller tube, eliminating the need for centre supports and minimising tube deflection allowing the awning to operate smoothly while keeping your fabric taut.

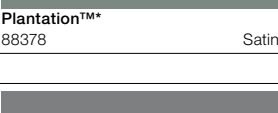
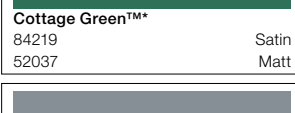

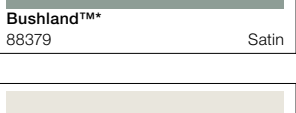
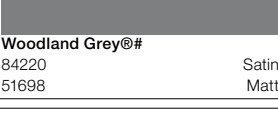
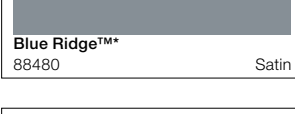
# LUXAFLEX® Additional *Powdercoating Colours*

 <b>Precious® Silver Pearl</b> 57225 Satin	 <b>White Satin</b> 32312 Satin	 <b>Primrose</b> 84365 Gloss	 <b>Shoji White</b> 84682 Satin
 <b>Stone Beige</b> 32538 Matt	 <b>Anotec® XT Off White</b> 51271 Matt	 <b>Rivergum Beige</b> 36991 Gloss	 <b>Pottery</b> 33662 Satin
 <b>New Hammersley Brown</b> 84657 Satin	 <b>Deep Brunswick Green</b> 50068 Gloss	 <b>Navy</b> 50282 Gloss	 <b>Old Pewter</b> 50243 Satin
 <b>Matt Black</b> 19319 Matt	 <b>Anotec® XT OSilver Grey</b> 51272 Matt	 <b>APO Grey</b> 32786 Satin	 <b>Notre Dame</b> 36672 Gloss
 <b>Classic Cream™*</b> 84755 Satin 84732 Matt	 <b>Sandbank®#</b> 88482 Satin	 <b>Jasper™*</b> 88479 Satin	 <b>Headland®#</b> 84761 Satin 84615 Matt
 <b>Manor Red™*</b> 84752 Satin 52094 Matt	 <b>Paperbark®#</b> 84212 Satin 51968 Matt	 <b>Pale Eucalypt®#</b> 84221 Satin 36648 Matt	 <b>Wilderness®#</b> 84224 Satin 52027 Matt
 <b>Plantation™*</b> 88378 Satin	 <b>Cottage Green™*</b> 84219 Satin 52037 Matt	 <b>Dune™*</b> 84763 Satin 84764 Matt	 <b>Bushland™*</b> 88379 Satin
 <b>Woodland Grey®#</b> 84220 Satin 51698 Matt	 <b>Blue Ridge™*</b> 88480 Satin	 <b>Deep Ocean®#</b> 83249 Satin 84713 Matt	 <b>Surfmist™*</b> 84608 Satin 84758 Matt
 <b>Shale Grey™*</b> 83246 Satin 84711 Matt	 <b>Windspray™*</b> 84760 Satin 85042 Matt	 <b>Ironstone™*</b> 88481 Satin	 <b>Night Sky™*</b> 19268 Satin 84702 Matt

NOTE: Colours are as close as printing process will allow.

# LUXAFLEX® *Folding Arm Awnings* Site Assessment

The Luxaflex range of Folding Arm Awnings are designed to offer protection from the harsh Australian sun. They offer style and functionality which has made them increasingly popular across Australia.

When choosing the awning that's right for your situation, you need to consider functionality and location. The Luxaflex Folding Arm Awning offers a number of options when installing the awning. Here are some tips to assist with quoting and installation of the awning.

Selecting the Luxaflex Folding Arm Awning and installation method appropriate for your home:

There are a range of installation options designed to assist in installing your awning. Depending on your application, you have the choice of:

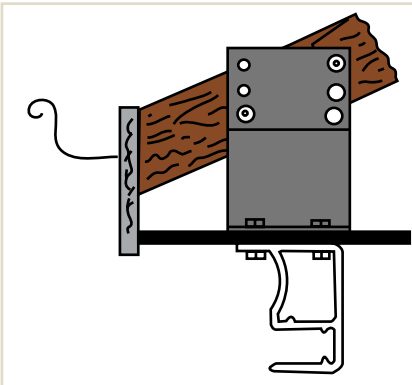

## 1) Mounting the awning under the eaves:

The rafter brackets are attached to the rafter with the mounting surface against the top of the eave lining, allowing the awning to be mounted directly under the eaves of the house.

## 2) Mounting the awning as a reverse fascia:

The reverse fascia bracket allows for even greater head clearance and is mounted in the same fashion as the fascia bracket.

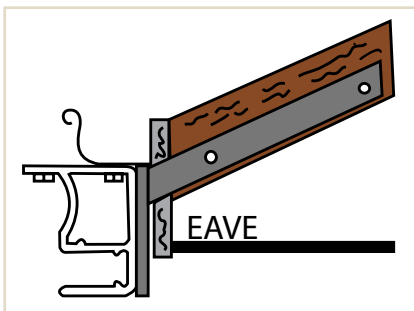
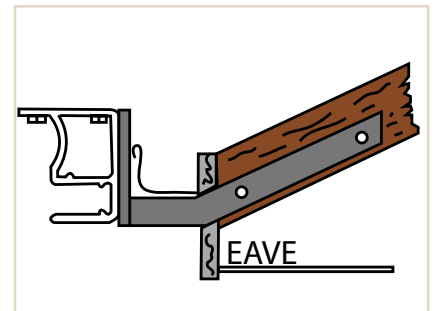

## 3) Mounting the awning through the fascia:

This option is selected if there is minimal head clearance. A slot is made next to the roof rafter through the fascia board. This allows the bracket to slide beside the roof rafter, which is then bolted together.

## 4) Mounting the awning as face fix onto brick.

The standard wall bracket is used to secure the awning onto the wall. Please ensure there are at least 7 courses of bricks above the mounting position. Optional spreader plate (42.583.000) can be used in combination with the awning bracket in order to spread the load more evenly over 3 courses of bricks.

Ensure there are a minimum of 4 courses of bricks below the mounting plate.

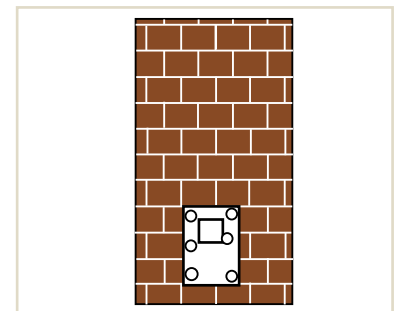



# LUXAFLEX® *Folding Arm Awnings* Site Assessment

## 5) Mounting the awning on a Flat roof:

The flat roof reverse fascia can be used in situations where the site has a flat roof with a concealed guttering.

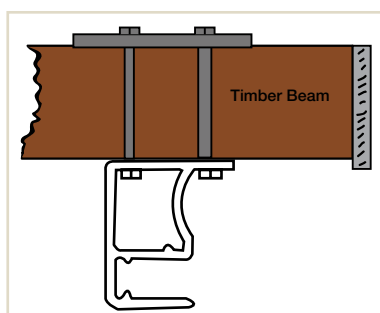
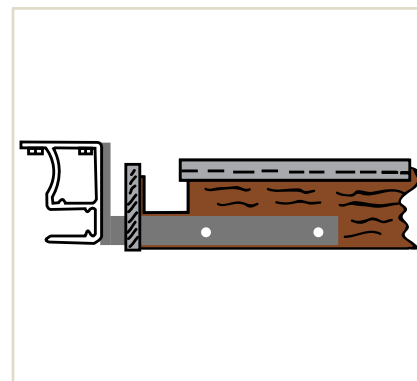

## 6) Mounting the awning onto exposed rafters:

The standard mounting bracket may be bolted directly onto the rafter using a backing plate.

If unable to use a backing plate, you may use a minimum of 100mm coach bolts X 10mm diameter to attach the brackets to the rafters.

## ASSESSING THE INSTALLATION SITE:

When deciding on where to fit your awning, there is a number of things that need to be considered to help ensure a successful installation.

This includes checking for the following:

### Check List

- |                                                                                                                                                                                                                                                                                          |   |
|------------------------------------------------------------------------------------------------------------------------------------------------------------------------------------------------------------------------------------------------------------------------------------------|---|
| 1) Determine the width required and ensure there are no obstructions that could interfere with the installation and operation of the awning. Consider things such as light fittings, doors, and power lines.                                                                             | ✓ |
| 2) Determine the projection that is required. The options for this include 1500, 2000, 2500, 3000, 3500 and 4000mm. When ordering the Sunrain Awning, please bear in mind that the awning has to be fully extended for it to operate properly in rainy conditions.                       | ✓ |
| 3) Consider the working area for the installer and ensure you take down adequate details to ensure the installer has the required tools to carry out the installation. Consider things such as working at heights, working near edges and any potential hazards such as uneven surfaces. | ✓ |
| 4) Consider the location of power for motorised awnings and choose a control side appropriate to the nearest connection point to power. Always select the control side when looking from outside to inside.                                                                              | ✓ |
| 5) To assist your installer, take site photos of items that may impact on the way the awning will be installed.<br><br>The more information you provide your installer about the site, the more prepared they will be for a successful installation.                                     | ✓ |
| 6) The type and size of awning selected will determine the quantity and position of installation brackets.<br><br>Please refer to the Product Reference guide section of your price list for these details.                                                                              | ✓ |



SMARTER BY DESIGN

